

ALBANY SHED CO
FLOOR PLAN: 909 LINCOLN 2.7 x 2.7m approx.

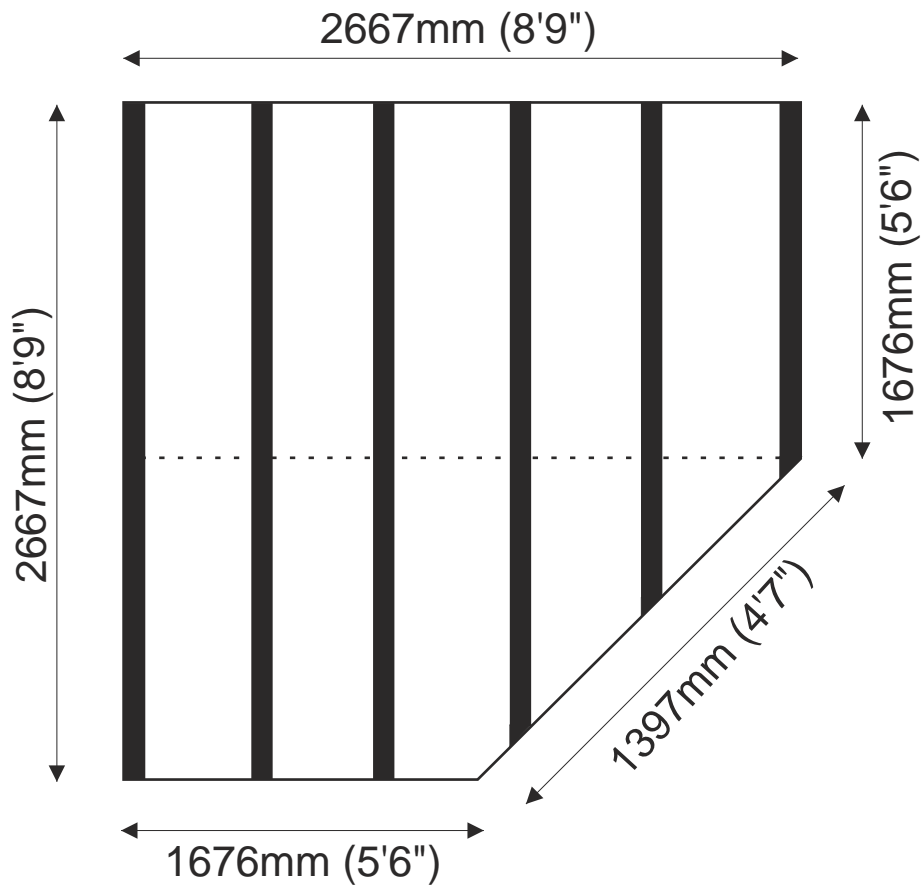

We reserve the right to alter design without prior notice