

ALBANY SHED CO

FLOOR PLAN: 603 GARDEN CHEST 1.8 x 0.9m approx.

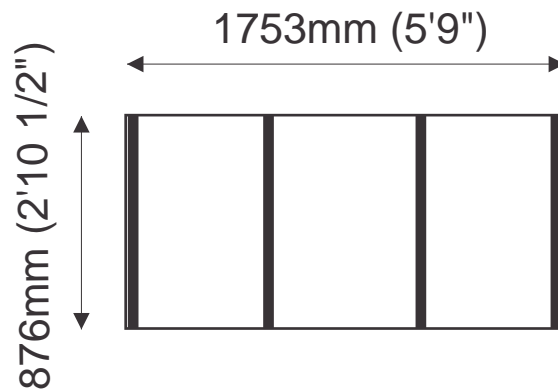

If using bearers we suggest 2 at 6ft (1.8m)

We reserve the right to alter design without prior notice.
If it is crucial that the floor joists run the same direction as shown above, this must be stated on the order.